



One of Canada's Premier Near-Term Re-Development Opportunities
in Mine-Friendly Quebec

Forward-Looking Information Disclaimer and Qualified Person

Certain statements in this presentation constitute forward looking information within the meaning of applicable securities laws. These statements relate to future events or AmAuCu Mining Corporation (to be named "Doré Copper Mining Corp.") ("Doré Copper" or "the Company"). Any statements that express or involve discussions with respect to predictions, expectations, beliefs, plans, projections, objectives, assumptions or future events or performance (often, but not always, using words or phrases such as "seek", "anticipate", "plan", "continue", "estimate", "expect", "forecast", "may", "will", "project", "predict", "potential", "targeting", "intend", "could", "might", "should", "believe", "outlook" and similar expressions) are not statements of historical fact and may be forward looking information. Forward looking information in this presentation includes, but is not limited to, statements with respect to financing targets, mineral resource estimates, drilling plans, financing success, sequencing of planned engineering studies, strategic plans, including future operations, future work programs, capital expenditures, discovery and production of minerals, metal prices and currency exchange rates, timing of geological reports, corporate and technical objectives, permitting success and relationships with stakeholders.

Forward looking information involves known and unknown risks, uncertainties and other factors which may cause the actual results, performance or achievements of the Company to be materially different from any future results, performance or achievements expressed or implied by the forward-looking information. Such risks include, among others, the inherent risk of the mining industry; adverse economic and market developments; the risk that the Company will not be successful in completing additional acquisitions, risks relating to the estimation of mineral resources; that the Company's estimated burn rate may be higher than anticipated; risks of unexpected cost increases; risks of labour shortages; risks relating to construction and development activities; risks relating to future prices of mineral resources; incidents; risks related to geological uncertainties and variations, risks related to labor disputes; risks related to government and community support of the company's projects and other risks related to the mining industry.

The Company believes that the expectations reflected in such forward-looking information are reasonable, but no assurance can be given that these expectations will prove to be correct and such forward-looking information should not be unduly relied upon. These statements speak only as of the date of this presentation. The Company does not intend, and does not assume any obligation, to update any forward-looking information except as required by law.

Resource Estimates, Qualified Person

In accordance with applicable Canadian securities regulatory requirements, unless otherwise stated, all current mineral resource estimates of the Company disclosed in this Presentation have been prepared in accordance with National Instrument 43-101 - Standards of Disclosure for Mineral Projects ("NI 43-101"), classified in accordance with Canadian Institute of Mining Metallurgy and Petroleum's "CIM Standards on Mineral Resources and Reserves Definitions and Guidelines" (the "CIM Guidelines").

Pursuant to the CIM Guidelines, mineral resources have a higher degree of uncertainty than mineral reserves as to their existence as well as their economic and legal feasibility. Inferred mineral resources, when compared with measured or indicated mineral resources, have the least certainty as to their existence, and it cannot be assumed that all or any part of an inferred mineral resource will be upgraded to an indicated or measured mineral resource as a result of continued exploration. Accordingly, readers are cautioned not to assume that all or any part of a mineral resource exists, will ever be converted into a mineral reserve, or is or will ever be economically or legally mineable or recovered. The Company is not aware of any environmental, permitting, legal, title-related, taxation, socio-political, marketing or other relevant issue that could materially affect the mineral resource estimate.

Unless stated otherwise herein, all scientific and technical data contained in this presentation has been reviewed, approved and verified by Andrey Rinta, P. Geo who is a qualified person for the purposes of ("NI 43-101") and is a member of the Association of Professional Geologists of Ontario - APGO. Mr. Rinta serves as Exploration Manager. Mr. Rinta verified all of the scientific and technical disclosure contained in this presentation by discussions with and/or supervision of the professionals who did the mineral resource estimations and provided other technical information in the report. The details of the mineral resource estimations and historical estimates are in the Appendices.

Reasons to Invest

Consolidated a large land package with brownfield deposits in emerging Lac Doré /Chibougamau Camp

- Mill complex accessible by road within 12 km from mining-friendly town of Chibougamau
- 12 deposits/resource target areas within 60 km of Doré Copper's 2,700 tpd mill
- Key deposits (Corner Bay, Cedar Bay, Copper Rand, Joe Mann) have over hundreds of millions of underground development with access through existing declines/shafts/portals

High-grade copper-gold resources following initial 19,000 m drill program

- Maiden resource at Cedar Bay deposit (360K tonnes at 8.72 g/t Au and 1.92% Cu)
- 93% increase in resource at Corner Bay deposit
- NI 43-101 M&I resources: 117M lbs Cu and 56K oz Au at 2.79% Cu and 0.91 g/t Au
- NI 43-101 inferred resources: 170M lbs Cu and 78K oz Au at 3.44% Cu and 1.09 g/t Au

25,000 m drill program in 2020 targeting high-grade extensions at Cedar/Corner Bay and Joe Mann

- Deposits remain open for expansion in numerous directions with many parallel veins
- Substantial regional exploration upside with many nearby consolidation opportunities
- Commencing PEA (targeted for 2021 and environmental baseline studies)
- Well-funded with ~C\$7M in cash at start of 2020

Experienced Leadership with a Strong Balance Sheet

Management

Ernest Mast – President, CEO, Director and Co-Founder

- Former President and CEO of Primero Mining, and Minera Panama (Inmet Mining)
- 20 Years with Xstrata/Noranda/Falconbridge

Jean Tanguay – General Manager

- Former Operations Manager with Campbell Mines

Andrey Rinta – Exploration Manager

- Former Senior Exploration Geologist with Kinross

Gavin Nelson – CFO

- CPA with experience in management of junior and small cap mining companies

Board of Directors

Mario Stifano – Executive Chairman and Co-Founder

- Former CEO of Cordoba Minerals and Former CFO of Lake Shore Gold

Frank Balint – Director

- Former VP Corporate Development and Exploration of Inmet Mining

Sara Heston – Director

- Former VP Investments of ASA Gold and Precious Metal

Matt Manson – Director

- President and CEO of Marathon Gold. Former CEO of Stornoway Diamonds

Brent Omland – Director

- CFO of Ocean Partners

Joseph de la Plante – Director

- Chief Investment Office, Nomad Royalty. Former VP Corp. Dev. of Osisko Gold Royalties

Advisory Board

- Mike Agnew – Former VP Technology Noranda Falconbridge and General Manager of the CEZ refinery
- Ewan Downie (Co-Founder) – President & CEO of Premier Gold Mines
- André Gaumond – Former Board member, Osisko Gold Royalties and former President and CEO of Virginia Mines

Capital Structure May 1, 2020

Share price (April 30, 2020 close)	C\$0.66
Basic shares outstanding	28.9M
Market capitalization (basic)	C\$19.1M
Working Capital	\$3.6M
Debt outstanding	Nil

1. 1.185M options outstanding at C\$0.50/share, 0.783M options outstanding at \$0.66/share
2. Includes 3.153M warrants at C\$1.95/share, 0.188M warrants at C\$1.30/share and 0.198M warrants at C\$1.43/share

Share Ownership

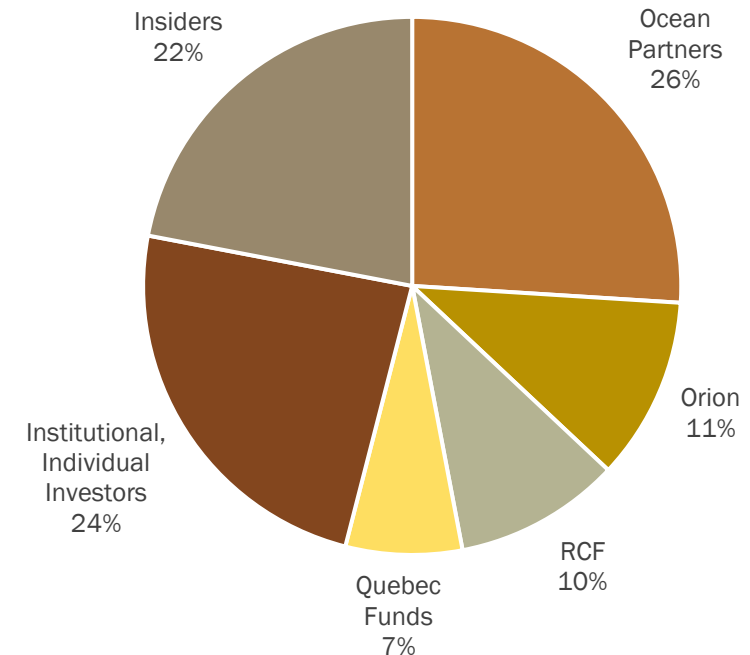

High-Grade Copper and Gold Deposits in the Emerging Chibougamau District in Quebec



Lac Doré (Chibougamau) mining camp has produced 1.6B lbs of copper and 3.2M ozs of gold

- Over 6,300 ha across the Lac Doré Camp
- Limited exploration in camp over past 20 years
- Deposits within 60 km of Doré Copper's Copper Rand plant (2,700 tpd of capacity)

Corner Bay

- 224.5 ha property (option on adjacent 2,110 ha)
- 2019 NI 43-101 resource estimate:
 - 3.01M tonnes at 3.47% Cu and 0.28 g/t Au
- \$25M spent on mine development prior to 2009
- 40K tonne bulk sample completed in 2008
 - Average grades of 2.48% Cu and 0.44 g/t Au
- Main vein remains open

Cedar Bay

- Part of 5,209 ha property located 8 km southeast of Chibougamau
- Mined to 670.5 m level from 1958 to 1990 (mined 3.9M tonnes at 1.63% Cu and 3.21 g/t Au)
- Existing shaft to 1,036 m level
- 2019 NI 43-101 resource estimate:

Copper Rand

- Largest historical mine in the Lac Doré camp (14.9M tonnes at 1.8% Cu and 2.76 g/t Au)
- Historical P&P reserves: 1.13M tonnes at 1.7% Cu and 2.93 g/t Au
- Historical MI,&I resources: 2.18M tonnes at 1.6% Cu and 2.87 g/t Au
- Remains open along strike and down dip

Devlin

- Mineralization within 80 meters of surface with decline to mineralized zone
- 2018 NI 43-101 resource estimate
 - 760K tonnes at 2.44% Cu and 0.24 g/t Au
- Flat-lying deposit with no identified feeders
- Easy access with potential for near-term mill feed

Lac Doré

- Mineralization within 80 meters of surface with access through double ramp
- Potential extension of Cedar Bay deposit off-set by a fault
- 1992 drill results. RD-10 3.45m 2.17% Cu, 12.6 g/t Au, RD-20 8.4m 1.26% Cu, 8.23 g/t Au

Joe Mann (option for 100%)

- Produced 1.17M oz Au, 607K oz Ag and 28.7M lbs Cu over 27 years between 1956 to 2007
 - Grades of 8.26 g/t Au, 5 g/t Ag and 0.25% Cu
- E-W striking shear hosted veins identified beyond 1 km depth and over a 1 km strike length
- Many targets across 1,990 ha property

High-Grade Copper and Gold Deposits

- Doré's Copper's properties contain some of the highest-grade undeveloped copper deposits in North America
- A rare copper focused developer with existing infrastructure and significant gold by-product credit
- Local mining expertise – no camp and only 14 km from Chibougamau by road
- Low capital intensity anticipated
- Excellent regional exploration potential

Under Ground Gold Deposits in Canada

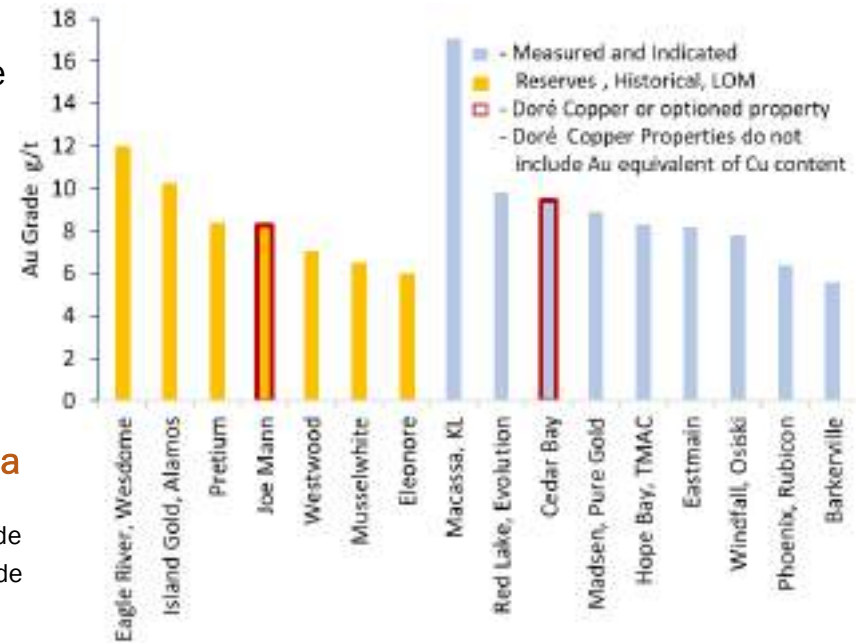

Highest Grade Undeveloped Copper Deposits in North America

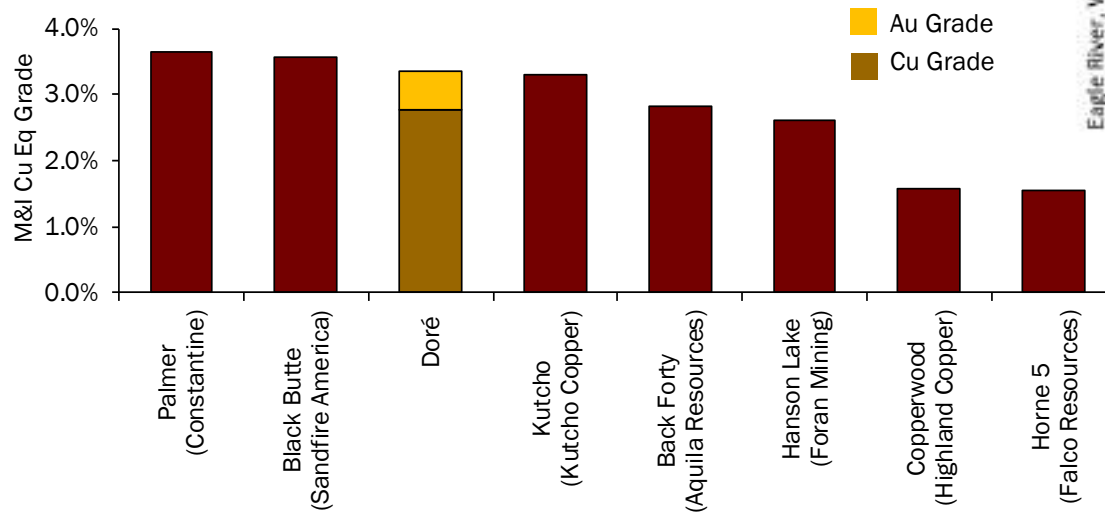

Note: Cu Eq based on M&I at Cedar Bay and Corner Bay on using US\$3.00/lb Cu and US1,300/oz Au. Not including Historic Resources at Copper Rand. Based on public disclosure

Key Infrastructure in Place

Copper Rand Processing Plant and Existing Tailings Capacity

- Mill is located 14km from the town of Chibougamau
 - Population of 7,500 with a long mining history
- Accessible by paved highway, rail, and daily scheduled air charters
- Operating 25 MW power line to site maintained by Hydro-Quebec
- Up to 2,700 tpd processing plant
 - Circuit includes crushing, grinding, gravity recovery of particulate gold, flotation of copper concentrate, thickening and filtration
 - Last operated in 2008
- Previously permitted tailings facility with 8.0M tonnes of capacity
 - Potential to expand with a berm raise
 - Existing tailings do not show acid rock drainage characteristics in water samples
- Site also includes a substation, core shack, laboratory, warehouse and office complex

Materially reduces future capex and timeline to production

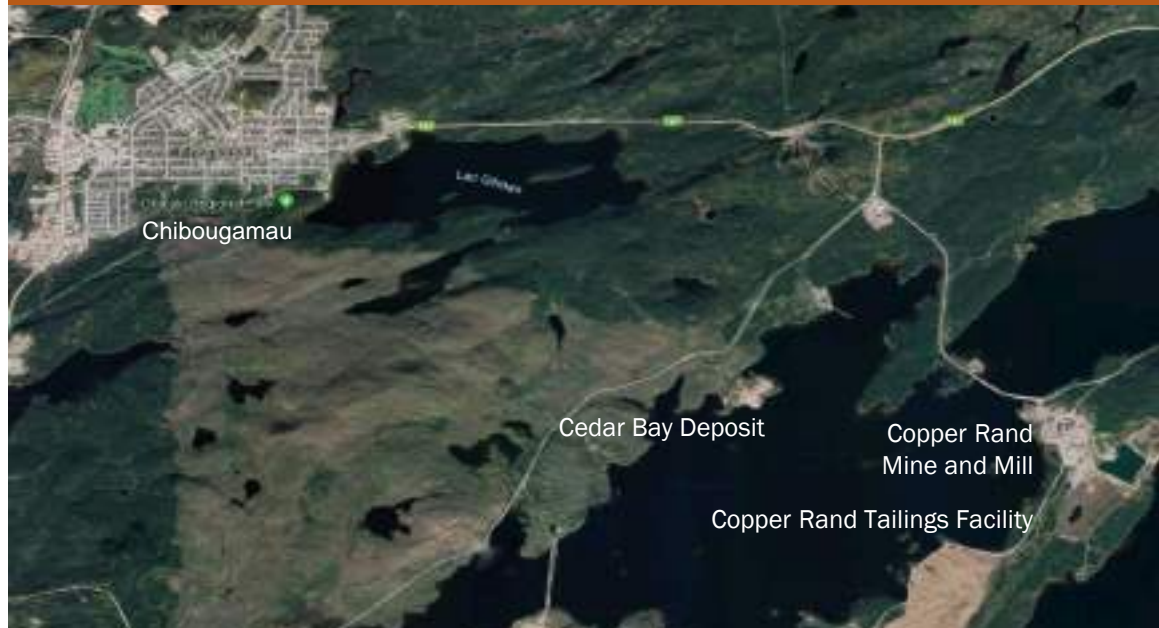

Close proximity to skilled labour and regional infrastructure (roads, rail, power, water)



8M tonnes of tailings storage capacity



2,700 tpd processing plant

History and Recent Timeline

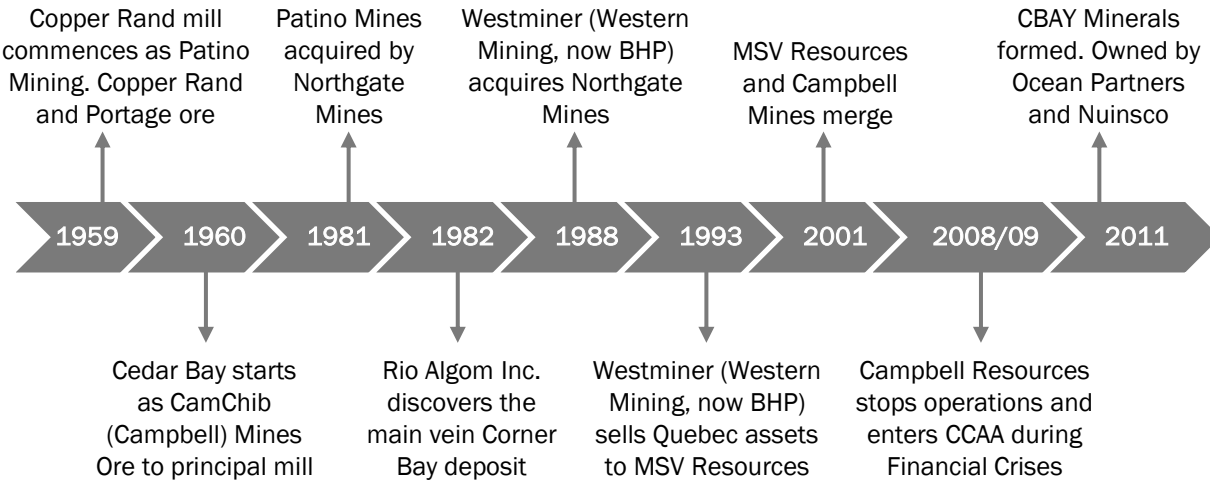

DORÉ COPPER MINING

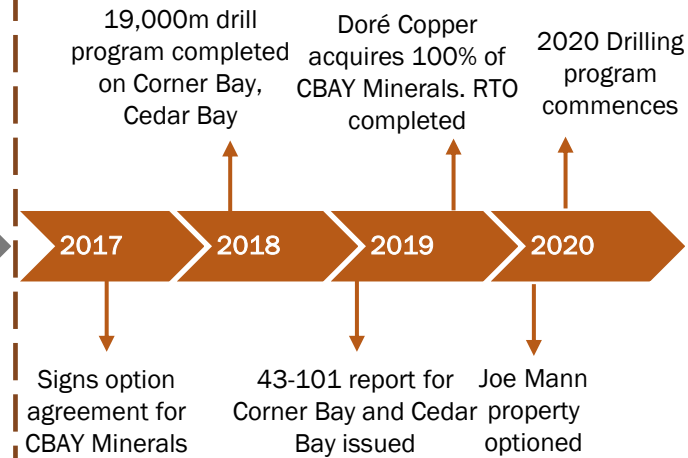

Initial Resource Across Several Growing Deposits

- 18,889 m drill program in 2017/2018 (14,047 m at Corner Bay and 4,842 m at Cedar Bay)
- Increased Corner Bay resource by 93%
- Maiden NI 43-101 resource estimate at Cedar Bay
- Low discovery cost of first drill program (C\$0.019/lb Cu Eq or C\$8/oz Au Eq)
- Deposits remain open for expansion in numerous directions with many known parallel veins
- Last and deepest zone mined at Copper Rand is open along depth and strike

Deposit	Category	Tonnage	Grade		Contained	
		000 tonnes	% Cu	g/t Au	M Lbs Cu	000 oz Au
<i>NI 43-101 Compliant Resource Estimates</i>						
Cedar Bay	Indicated	130	1.55	9.44	4.4	39
	Inferred	230	2.13	8.32	10.8	61
Corner Bay	Indicated	1,351	3.01	0.29	89.8	13
	Inferred	1,660	3.84	0.27	140.3	15
Devlin	Measured & Indicated	412	2.48	0.27	22.5	4
	Inferred	347	2.40	0.19	18.4	2
Total	Measured & Indicated	1,893	2.79	0.91	116.6	56
	Inferred	2,237	3.44	1.09	169.7	78
<i>Historical (Non-NI 43-101 Compliant Resource Estimate)</i>						
Copper Rand	Proven & Probable	1,130	1.66	2.93	41.5	106
	Measured & Indicated	1,762	1.56	2.90	60.5	164
	Inferred	416	1.89	2.77	17.3	37

Corner Bay Deposit

High-Grade Copper Zones with Substantial Underground Development

- \$25M spent on development prior to 2009
 - Ramp access to a vertical depth of 115 m with 2 km of development over 3 levels (55 m, 75 m and 105 m)
- 40K tonne (at 2.48% Cu and 0.44 g/t Au) bulk sample processed at the Copper Rand Mill in 2008
 - Average recoveries of 94% Cu and 62% Au
- Near term production potential
 - Ore trucked to Copper Rand Mill (45km)
- Excellent expansion potential at depth and along strike and other structures
- Dominant land position in the Corner Bay area
 - 2,110 ha of additional land acquired in an option agreement
 - 4 strong geophysical targets



NI 43-101 Compliant Resource Estimate (December 31, 2018)¹

Category	Vein	Tonnage	Grade		Contained	
		M tonnes	% Cu	g/t Au	M Lbs Cu	000 oz Au
Indicated	Vein 1	0.80	3.08	0.31	54.4	8
	Vein 2	0.30	2.75	0.28	18.3	3
	Main Below Dike	0.25	3.11	0.22	17.0	2
	Total	1.35	3.01	0.27	89.8	13
Inferred	Vein 1	0.45	2.91	0.24	28.7	3
	Vein 2	0.08	2.82	0.22	5.1	1
	Main Below Dike	0.75	3.12	0.18	51.7	4
	Lower Deep	0.38	6.58	0.50	54.9	6
	Total	1.66	3.84	0.27	140.3	15



- Increased Corner Bay's resource estimate by 93% after a 14-hole, 14,047 m drill program from October 2017 to May 2018.

1. Resource estimate prepared by qualified person Luke Evans (M.Sc., P.Eng.) of Roscoe Postle Associates Inc. with an effective date of June 15, 2019. Mineral resources are estimated at a 1.5% cut-off and using a copper price of US\$3.25/lb and exchange rate of US\$1.00:C\$1.25. Minimum mining width of 2 m was used. Bulk density was 3.1 t/m³ for Vein 1 and 2 and 2.8 t/m³ for Main Below Dike and Lower Deep veins. Numbers may not add due to rounding

Corner Bay Deposit

Numerous Opportunities for Resource Expansion

- Main vein remains open – potential for new veins
- 60% of drilling meters planned in 2020 to be drilled at Corner Bay for expanding known veins and discovering new zones

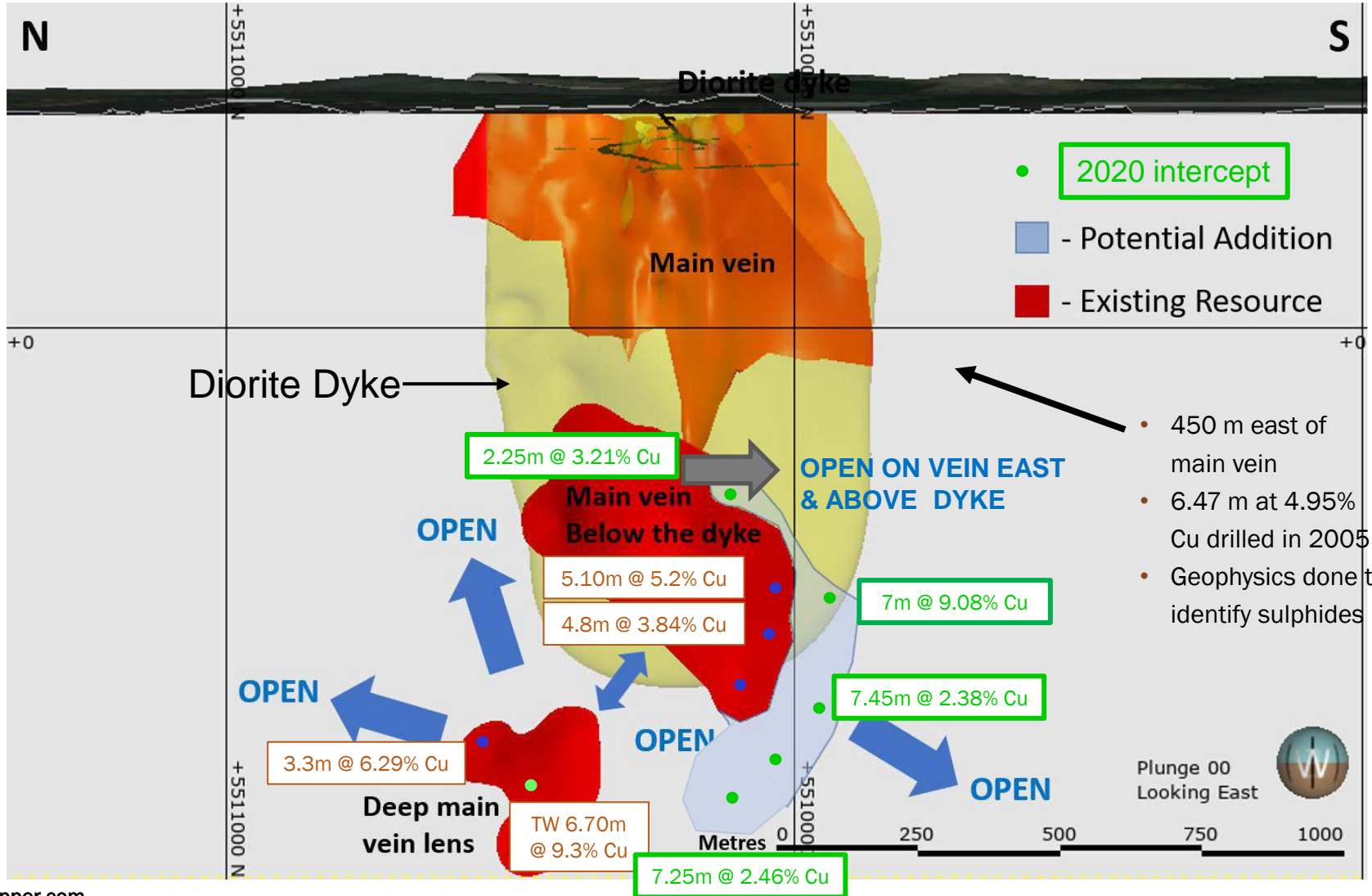

Cedar Bay Deposit

Defined High-Grade Gold Extension Near Past-Producing Mine

- Comprised of a set of extensional shear veins that formed perpendicular to and from the displacement along the Lac Doré fault
- Mined to the 670.5 m level from 1958-1990
 - Mined 3.9M tonnes at 1.63% Cu and 3.21 g/t Au
 - Existing shaft extends to 1,036 m, while development extends to the 754.3 m level
- Majority of ore mined from the main zone and the NE parallel structure of the 10-20 Zone
- 300K tonnes of ore at 0.97% Cu and 5.45 g/t Au beneath workings (non-NI 43-101 compliant)

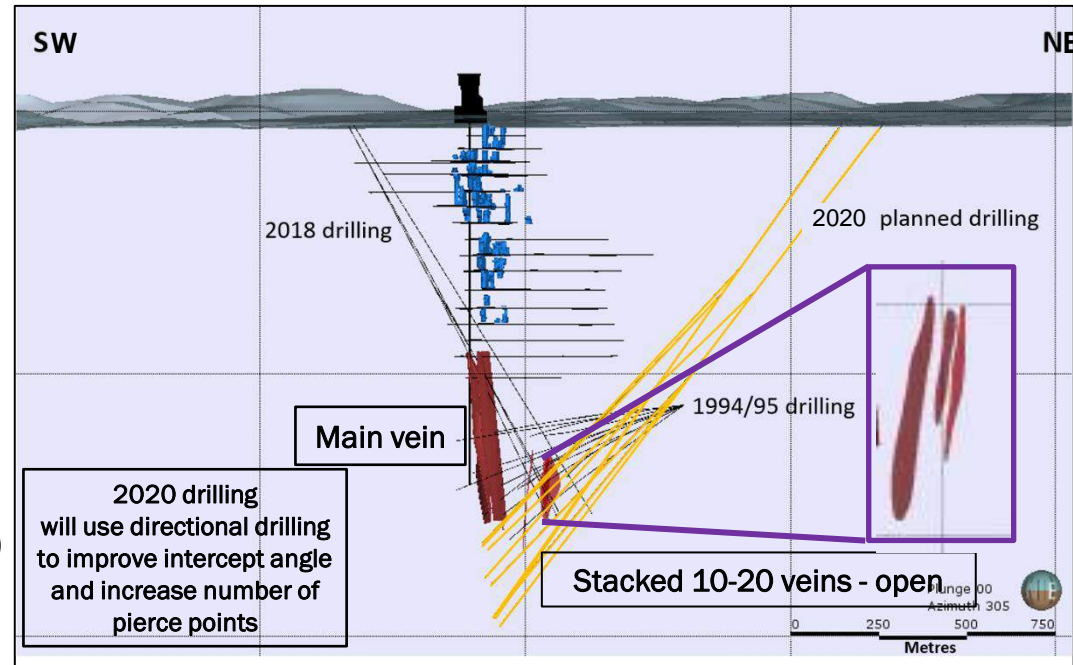

NI 43-101 Compliant Resource Estimate (December 31, 2018)¹

Category	Vein	Tonnage	Grade		Contained	
		000 tonnes	g/t Au	% Cu	000 oz Au	M lbs Cu
Indicated	10 -20 area	130	9.44	1.55	39	4.4
Inferred	10 -20 area	230	8.32	2.13	61	10.8

1. Resource estimate prepared by qualified person Luke Evans (M.Sc., P.Eng.) of Roscoe Postle Associates Inc. with an effective date of June 15, 2019. Mineral resources are estimated at a 2.9 g/t Au cut-off and using a gold price of US\$1,400/oz and exchange rate of US\$1.00:C\$1.25. Minimum mining width of 2 m was used. Bulk density of 2.90 t/m³ was used.

- Mineralization is open at depth and extends well below existing shaft in high grade structures. Drill hole examples from 2018.
 - 2.4 m at 4.54% Cu and 15.4 g/t Au
 - 2.4 m at 1.67% Cu and 19.5 g/t Au

Drilling in 2020 will expand 10-20 zones and target the Main Vein for inclusion in the Estimated Resources.

Joe Mann Deposit

Potential for High-Grade Discoveries at one of the Prolific Former Gold Mines at the Chibougamau Camp

- Option to acquire 100%
 - Total remaining payments of \$3.25M and \$2 M equivalent in shares prior to Jan 2, 2023
 - \$2,500,000 in expenditures by Jan 2, 2023
 - See appendix for more details
- One of the largest producing gold mines in the Chibougamau district
 - Operated for 27 years (1956 to 2007)
 - Produced 1.17M oz of gold at 8.26 g/t Au, 607K oz of silver at 5 g/t Ag and 28.7M pounds of copper at 0.25% Cu.
 - Ore treated at Copper Rand mill from 2004 to 2007

Long-section of the Joe Mann deposit. Blue and red are the two parallel vein zones

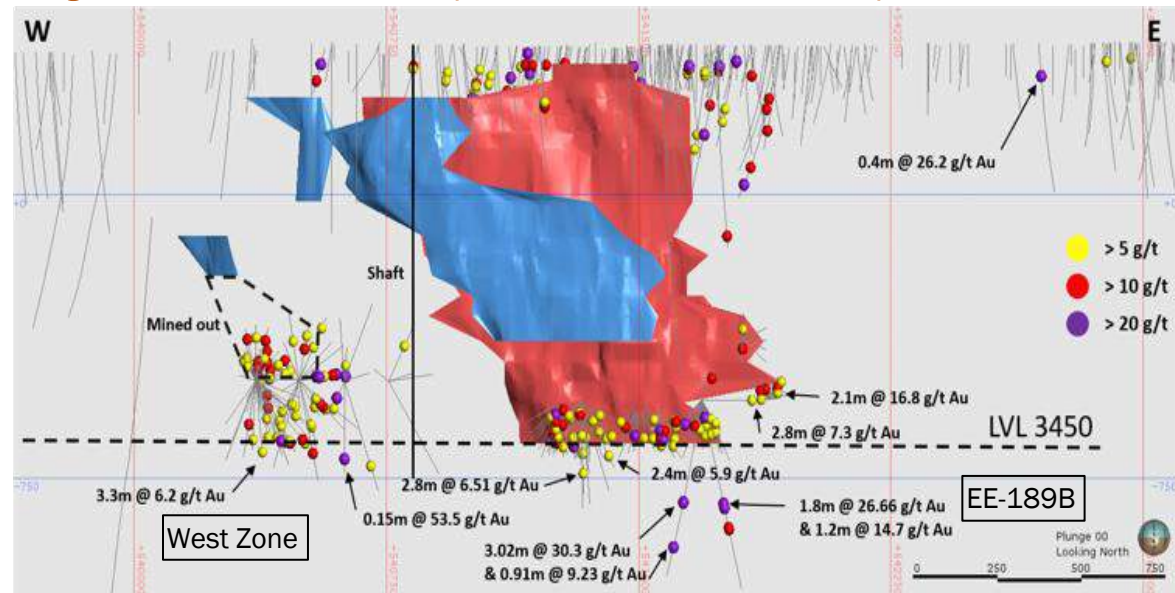

- Substantial mine development remains, including a shaft down to the 1,145 m level
- E-W striking shear hosted veins that extend over 3 km strike to depth of over 1 km
- In 2007-08, two holes intersected high grade gold 170 m below lowest level (1,050 m) of mine (never followed up)
 - Hole EE-189B intersecting **1.8 m at 26.66 g/t Au** and Hole EE-188 intersecting **3.02 m at 30.3 g/t Au and 1.3% Cu**
- Significant potential for thick high-grade mineralization at the West Zone (subject to limited drilling)
 - Historical intercepts from unmined areas include 5.0 m at 10.3 g/t Au, 3.2 m at 16.1 g/t Au and 3.3 m at 10.4 g/t Au
- New parallel zones have been identified by recent surface prospecting work that lie several hundred meters to the south of the main mined zone
 - Magnetic survey identified numerous high-priority exploration targets
 - Deposit was minimally explored to the south

Copper Rand Deposit

Potential Re-Start of Past Producing Copper-Gold Mine

- The largest past producing mine in the Lac Doré Camp
 - Mined 14.9M tonnes at 1.8% Cu and 2.76 g/t Au from 1959 to 2008
 - Mining of CR5000 Zone accessed through Shaft 4 to the 1,213 m level and 1,500 m decline
- Little exploration over last years of operations
 - Primarily due to financial distress of previous operator (Campbell Resources)
- Excellent potential below previously mined areas, which remain open along strike and down dip

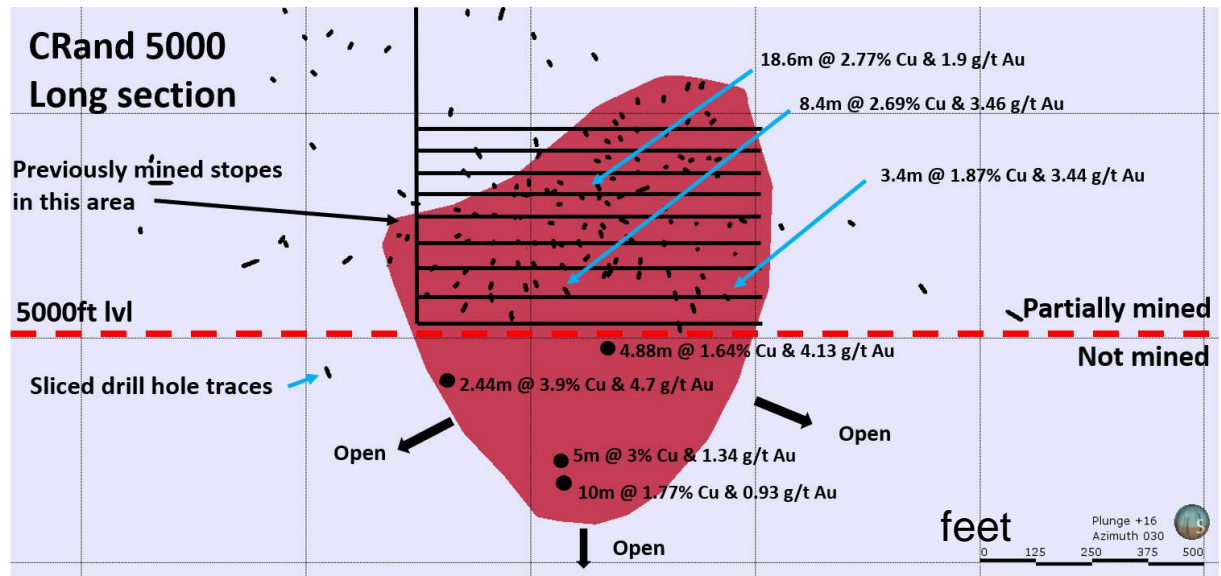

Historic Reserves and Resources (as of December 31, 2007)

Category	Tonnage		Grade		Contained	
	000 tonnes	% Cu	g/t Au	M Lbs Cu	000 oz Au	
Proven & Probable Reserves ¹	1,130	1.66	2.93	41.5	106	
Measured & Indicated Resources ²	1,762	1.56	2.90	60.5	164	
Inferred Resources ²	416	1.89	2.77	17.3	37	

As shown in U.S. S.E.C. filings by Campbell Resources, Form 20-7 Annual report for the period ending December 31, 2007. Prepared by QP. V. Larouche, Ing. (chief geologist of Campbell Resources).

- Reserves were calculated using a US\$800/oz gold price, US\$2.75/lb copper price and exchange rate of US\$1.00:C\$1.00. Grades capped at 13.71 g/t Au and 6.0% cu. Polygon on orthogonal projection. Cut-off \$58 NSR. Subsequent to this reserve and resource estimate, 183,348 tonnes were treated at an average grade of 2.1% Cu and 2.36 g/t Au. recovery 96.6%, Au recovery 81.33%.
- M&I resources are inclusive of P&P reserves. Resources calculated at a US\$800/oz gold price, US\$2.75/lb copper price and exchange rate of US\$1.00:C\$1.00. Recoveries of 96.6% for copper and 81.33% for gold. Gold grades capped at 13.71 g/t and copper grades capped at 6.0%. Polygon on orthogonal projection. Cut-off \$58 NSR. Used densities of 3.64 t/m³ for siderite veins, 3.60 t/m³ for high-grade veins, 3.27 t/m³ all other veins and 2.91 t/m³ for waste mining dilution. Vein width distribution: 1.81m - 2.43m = 40%, 2.43m - 3.05m = 30%, 3.05m - 4.57m = 20%, 4.751m - 7.62m = 15%, and >7.621m = 10%. Dilution grades of 0.25% Cu and 0.31 g/t Au used based on drill core analysis adjacent to veins. Projections determined using Promine software. Minimum true width used 1.82 m.

Devlin Deposit

Near Surface Optionality

- Flat-lying (horizontal) magmatic massive sulfide deposit close within 100 m of surface
- Existing decline to mineralized zone
- Vertical feeders have yet to be identified
 - The feeder structure is likely to be one of the main NE trending faults (Lac Doré parallel) and could be very similar to the Henderson mines in the north
- Further drilling will be focused on trying to identify a sub-vertical feeder structure and identifying off-set extensions of the deposit under the lake

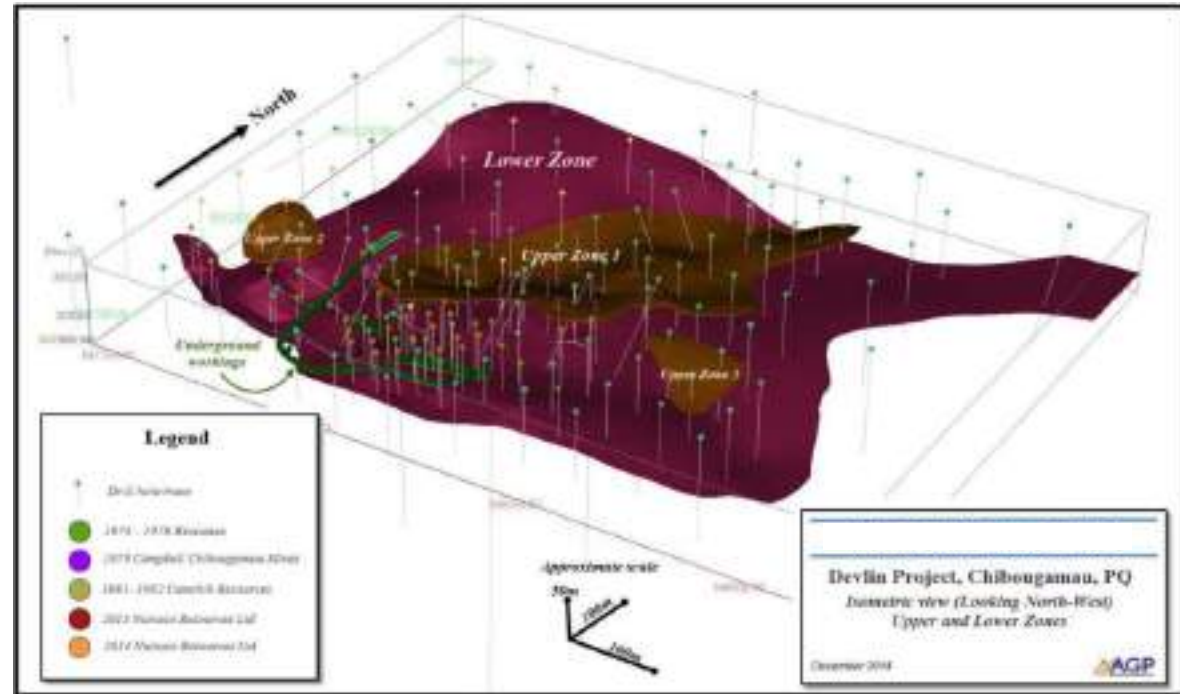

NI 43-101 Compliant Resource Estimate (August 20, 2015)¹

Zone	Category	Tonnage	Grade		Contained	
		Tonnes	% Cu	g/t Au	M lbs Cu	000 oz Au
Lower	Measured & Indicated	412,400	2.48	0.27	22.5	3.6
	Inferred	336,800	2.42	0.19	18.0	2.1
Upper	Inferred	10,500	1.79	0.31	0.4	0.1

1. Resource estimate prepared by qualified person Pierre Desautels (P. Geo) of AGP Mining Consultants Inc. with an effective date of August 20, 2015. Mineral resources are estimated at a 1.6% Cu cut-off. Minimum mining width of 1.8 m was used. Bulk density of 2.87 t/m³ was used.

Lac Doré Deposit

- Shallow gold – copper deposit located close to the Copper Rand mill
 - Mineralization within 80m of surface and has an existing double ramp
- Deposit was mined by Westminer in the last 1980s and early 90s
 - Accessed through a double ramp
 - Mine was shut down in 1991 due to low gold prices
- Potential for extension of Cedar Bay deposit
 - Based on theory of horizontal displacement along the Lac Doré fault
- Deposit not explored towards Lac Doré fault, nor towards SE and not at depths greater than 400 m
 - Deposits in region have depths of over 1.5 km
- Numerous excellent assays of +1% Cu and +5 g/t Au from drill holes 1987 to 1992 by Northgate Mines and Westminer Canada Lte.
 - RD-10, 3.45m 2.17% Cu, 12.6 g/t Au,
 - RD-20, 8.4m 1.26% Cu, 8.23 g/t Au

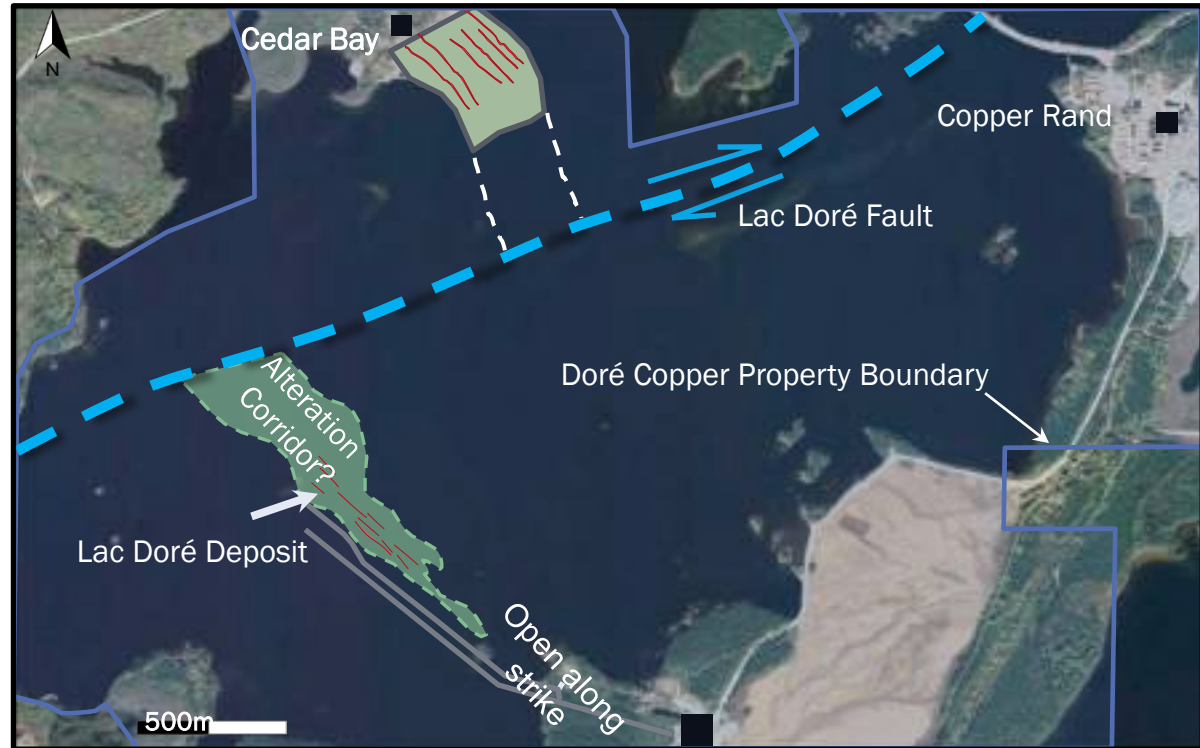

Active Engagement with All Stakeholders

- Cree Nation based in Ouje-Bougoumou
 - Experienced with mining and natural resources. Will start with pre-development agreement and eventually an IBA
- Investissement Quebec (IQ)
 - Doré Copper participates in SME New York Mine Finance IQ sponsored conference
- Municipality of Chibougamau
- Numerous other companies in the area
- Quebec Investment Funds – potential investors
- MERN
 - Closure plans to be developed for each deposit after mine restart plans developed
- MELCC (environment)
 - Approval for small remediation projects obtained
- Plan Nord
 - Cooperation in development of mines
 - Doré Copper participation in Plan Nord sponsored supplier 1 on 1s
- Societe de developpement de la Baie James
 - Group holds \$5.3M closure bond for Copper Rand site
- SOQUEM
 - Partner on Tortigny property and neighbour in a few areas in the Chibougamau Camp



Photo: view of tailings water discharge area

Next Steps

25,000 m exploration program planned for 2020 leading to a PEA in 2021

2020

- 20,000 m step-out drilling at Corner Bay and Cedar Bay
- 5,000 m Determine down dip potential at Joe Mann
- Evaluate drilling deposits along structure and at depth
- Initial drilling of Lac Doré targets
- Environmental baseline studies

2021/2022

- Additional drilling, exploration and infill
- PEA
- Mine design and rehabilitation plans
- Detailed sequential mill rehabilitation cost
- Concurrent permitting process
- Advance First Nations IBA
- Regional exploration program
- Advance towards Feasibility studies



Summary

One of Canada's premier, near-term development opportunities in mine-friendly Quebec

Large 6,000 ha+ land package in the emerging Lac Doré Camp near Chibougamau

Excellent infrastructure

- 2,700 tpd mill,
- Tailings facility (8M tonnes capacity)
- Brownfield deposits with underground development/access

Three brownfield deposits with high-grade NI 43-101 compliant copper-gold resources

Well funded with a 25,000 m drill program in 2020 to provide many near-term catalysts



Appendix



Doré Copper's Land Position in Chibougamau

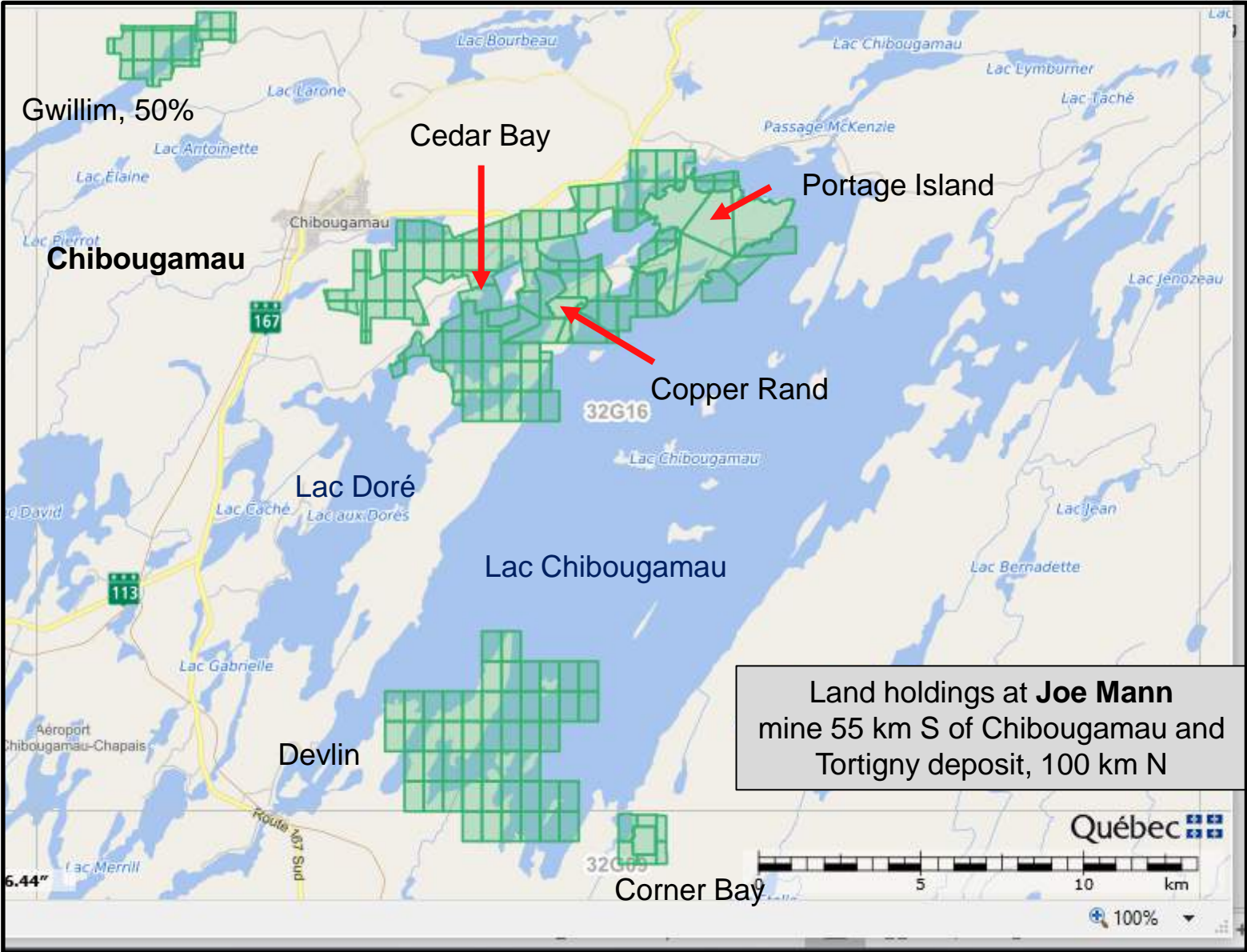

Chibougamau Area Geology

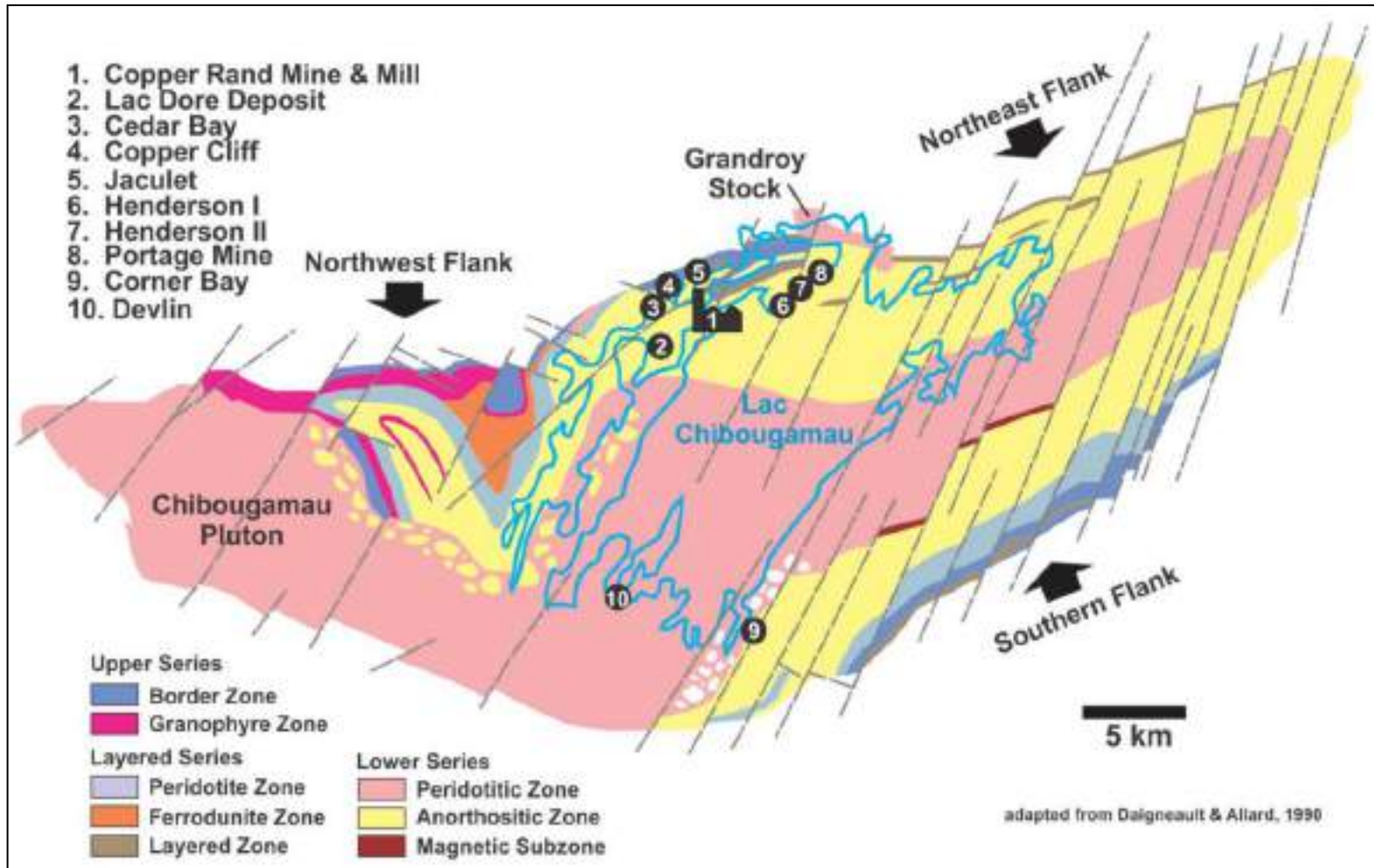

Corner Bay Drilling – Long Section

Long Section looking east – Immediately below the dike. Every 2018 drill hole intersected mineralization

Remains open for expansion

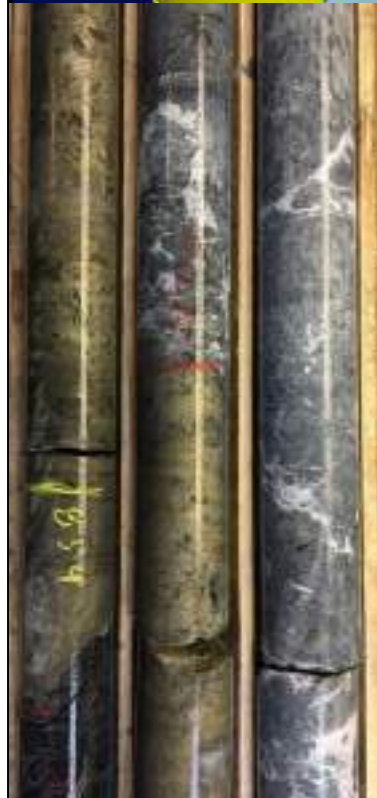
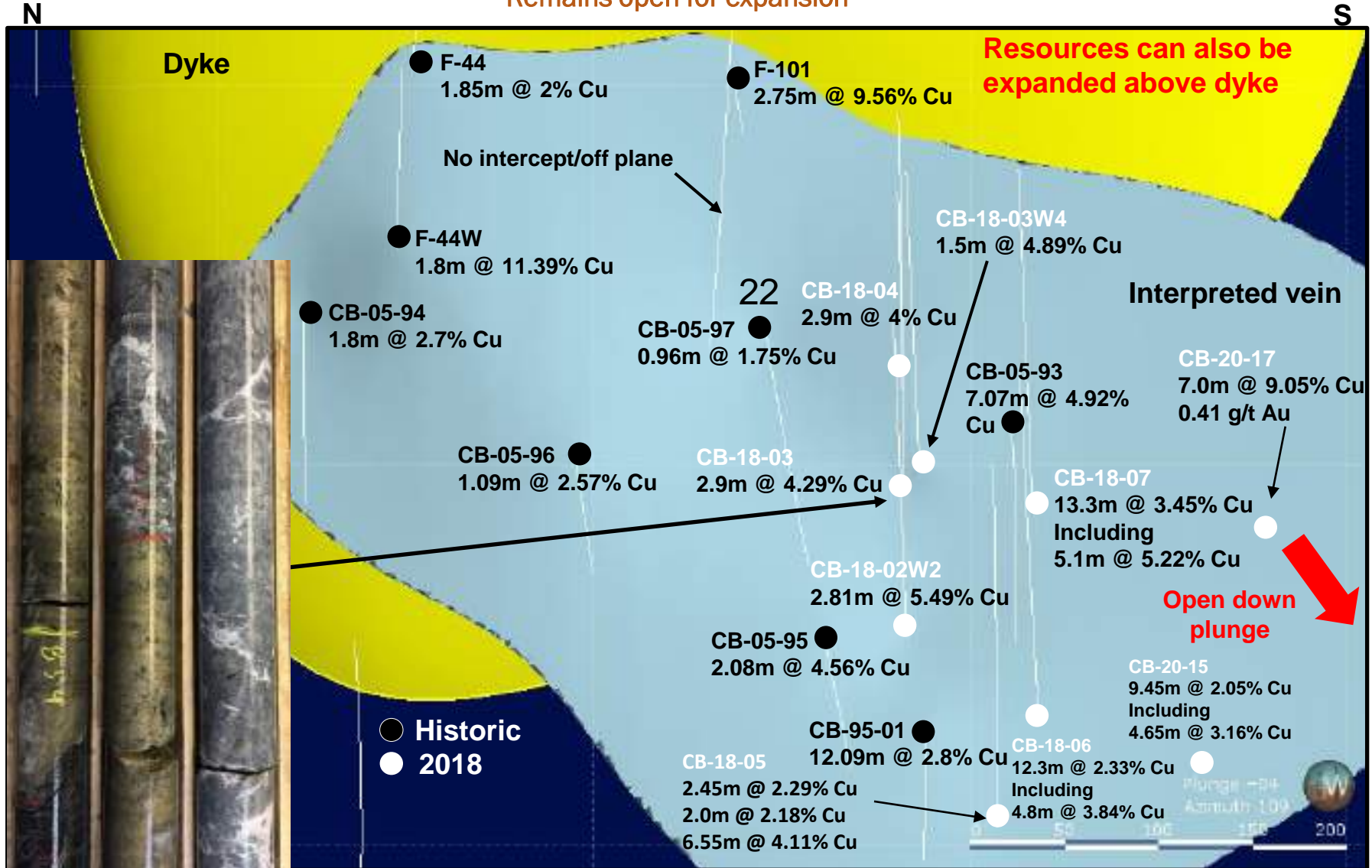

Cedar Bay and Copper Rand Deposits

- Located across Lac Doré from each other
- Strategy for Copper Rand can be to rehabilitate its shaft or access via Cedar Bay
 - Trade off to include dewatering vs keeping a pillar
- Copper Rand and Cedar Bay can share infrastructure
 - Maintenance shop
 - Shaft and mining equipment, if connected
- Although the deposits are close, they are only related in that they are extensional faults off the Lac Doré fault

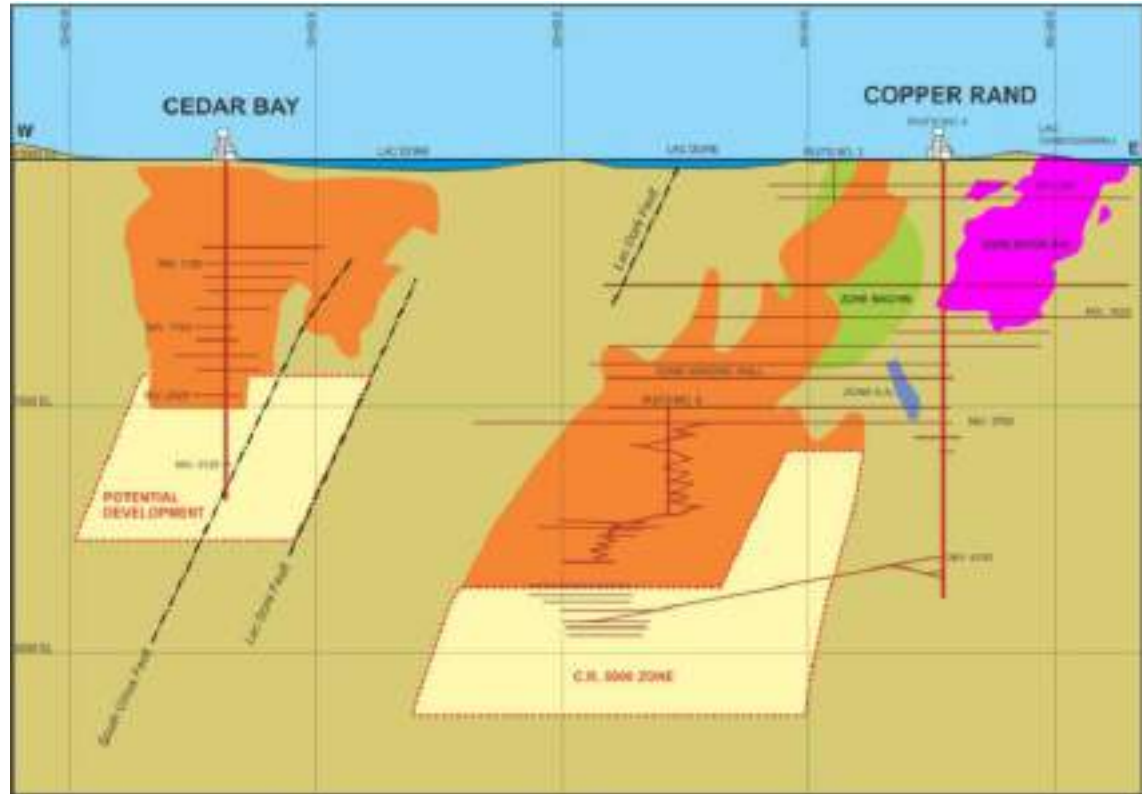

Cedar Bay Mine – Drilling Confirmed High Grade

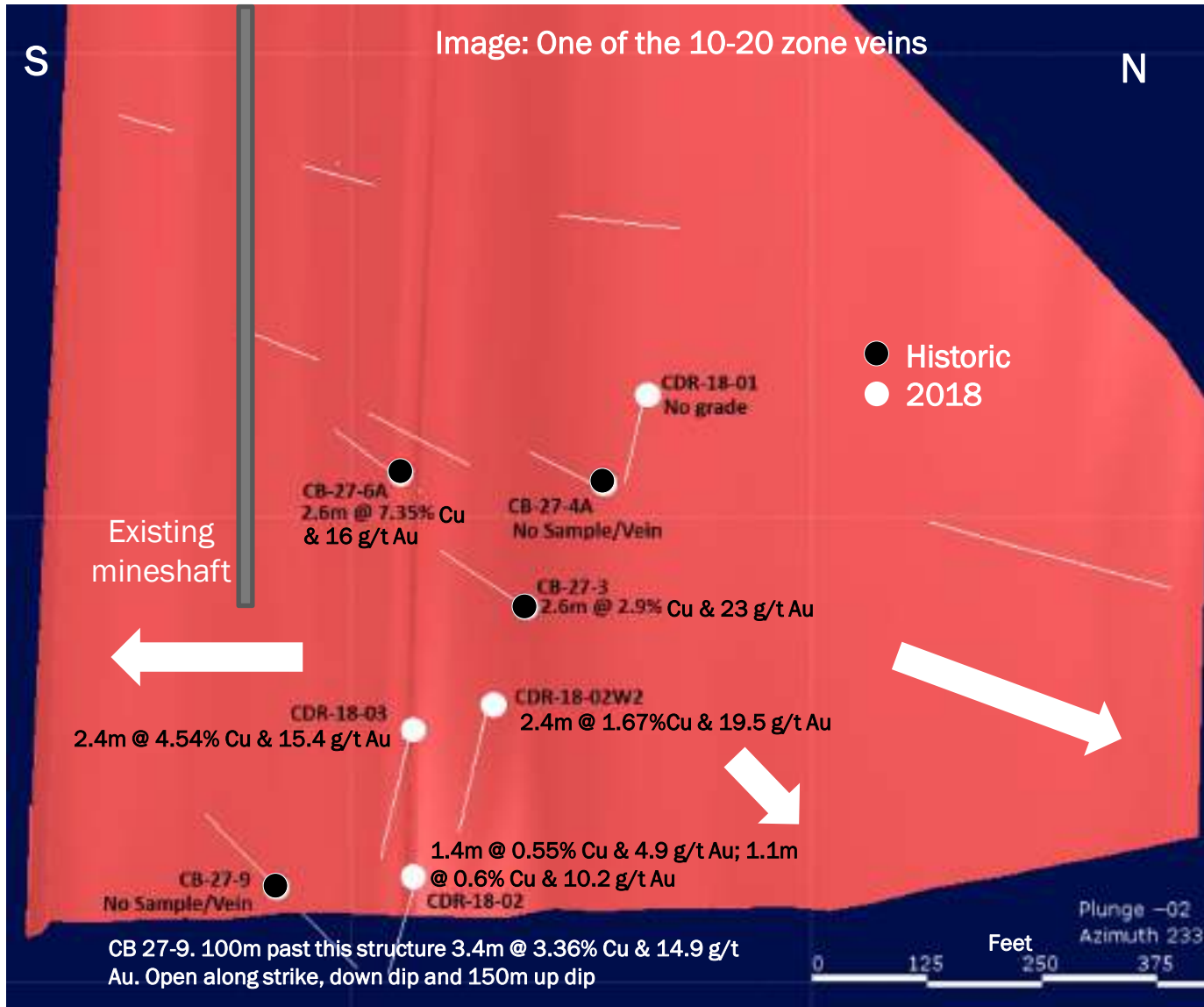

New Resource Potential: Portage Island

- Large gaps in previous drilling

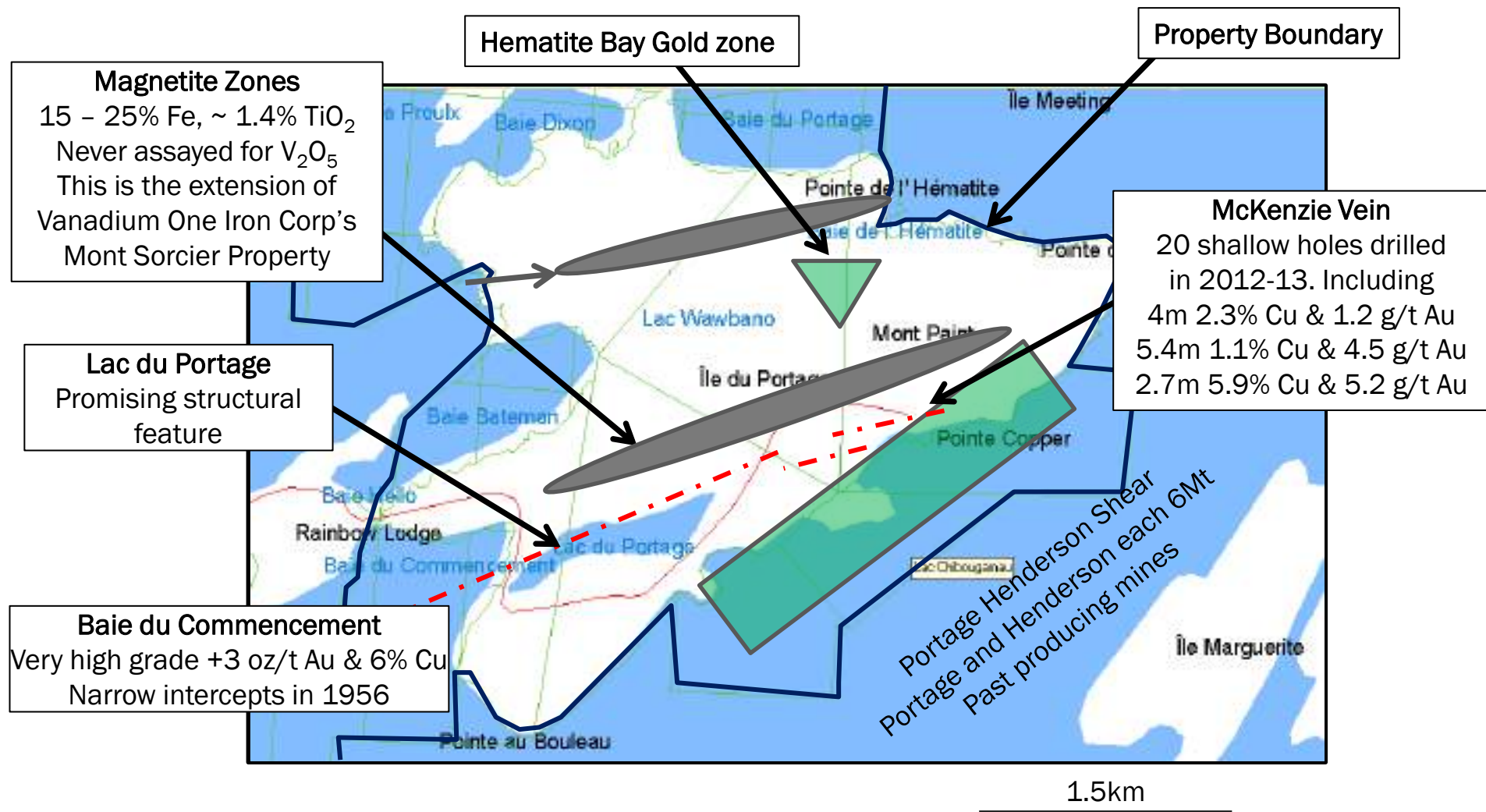

Process Plant – Existing Flowsheet

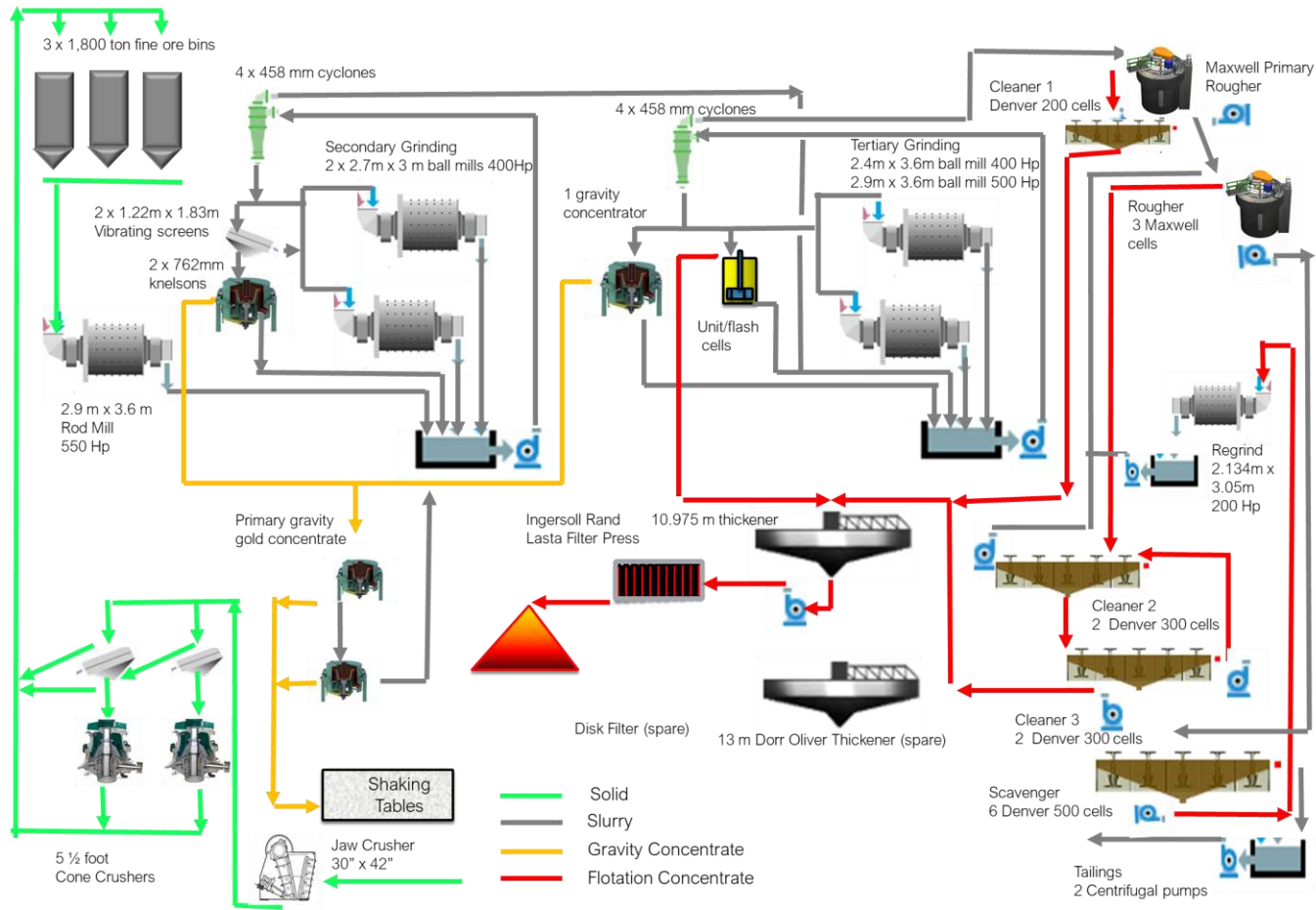

- Mill last operated in 2008.
- Extra processing equipment so mill can be operated at reduced tonnage

Option Agreement on the Joe Mann Property

- Doré Copper entered into an option agreement January 2, 2020 with the owners of Joe Mann, Ressources Jessie Inc. ("Ressources Jessie") and Legault Metals Inc. ("Legault"), to acquire a 100% interest in Joe Mann property based on the following terms:
 - A cash payment of C\$1,000,000 to Ressources Jessie and 400,000 common shares of Doré Copper to be issued to Legault at a deemed price of C\$1.25 per share on the effective date of the option agreement ("Effective Date")
 - A cash payment of C\$250,000 to Ressources Jessie and C\$500,000 in common shares of Doré Copper to be issued to Legault on the first anniversary of the Effective Date
 - A cash payment of C\$1,000,000 to Ressources Jessie upon completion of 5,000 m of drilling at Joe Mann or on the earlier of the second anniversary of the Effective Date or 18 months from the commencement of drilling
 - A cash payment of C\$500,000 to Ressources Jessie and C\$500,000 in common shares of Doré Copper to be issued to Legault on the second anniversary of the Effective Date
 - A cash payment of C\$1,500,000 to Ressources Jessie and C\$1,000,000 in common shares of Doré Copper to be issued to Legault on the third anniversary of the Effective Date.
 - Spending C\$2,500,000 in qualifying exploration expenditures before the third anniversary of the Effective Date
 - A cash payment of C\$1,000,000 to Ressources Jessie and C\$1,500,000 in Doré Copper Shares to be issued to Legault upon the commencement of commercial production at Joe Mann
 - A 2% net smelter return royalty will be granted to Ressources Jessie and the Corporation will hold the option to buy back 1% for C\$2,000,000 and buy back a further 0.5% for C\$4,000,000
- The terms and conditions of the option agreement are subject to approval from applicable regulatory authorities, including the TSX Venture Exchange
- Technical Report on the Joe Mann Mining Property dated January 11, 2016 was prepared by Geologica Inc., Alain-Jean Beaugard, P. Geo, OGQ. Daniel Gaudreault, Ing Geol, OIQ